

FR

CS

DA

DE

EL

EN

ES

FI

IT

NL

NO

PL

PT

RU

SK

SV

USER GUIDE

COMBI-STEAM OVEN

EN

DEAR CUSTOMER, CUSTOMER,

Discovering a De Dietrich product means experiencing the range of unique emotions. The attraction is immediate, from the moment you set eyes on the product. The sheer quality of the design shines through, thanks to the timeless style and outstanding finishes which make each component an elegant and refined masterpiece in its own right, each one in perfect harmony with the others.

Next, comes the irresistible urge to touch it.

De Dietrich design makes extensive use of robust and prestigious materials, where the accent is placed firmly upon authenticity.

By combining state-of-the-art technology with top quality materials, De Dietrich produces beautifully crafted products to help you get the most from the culinary arts, a passion shared by all lovers of cooking and fine food. We hope that you enjoy using this new appliance.

Thank you for choosing a De Dietrich product.



BVCert.6011825

The label "Origine France Garantie" assures the consumer the traceability of a product by giving a clear and objective indication of the source. The DE DIETRICH brand is proud to affix this label on products from our French factories based in Orléans and Vendôme.

www.dedietrich-electromenager.com



De Dietrich

CONTENTS

Safety and important precautions	4
1 / Installation	6
2 / Environment	7
3 / Description of the oven.....	9
The controls and display.....	10
The accessories	11
The refill tray.....	12
Initial settings - using the oven for the first time	13
4 / The cooking modes.....	14
“Expert” mode.....	15
“Expert steam” mode	15
◦ Favourites (saved cooking programmes).....	17
◦ Cooking functions.....	18
◦ Drying	20
“Cooking guide” mode	21
“Combined steam” mode	23
◦ List of dishes	24
5 / Settings	25
Locking the controls	26
6 / Minute Minder	26
7 / Maintenance - Cleaning	27
External surface.....	27
Removing the shelf runners.....	27
Cleaning the inner glass	27
Removing and putting back the door.....	27
Replacing the light bulb	29
Cleaning function.....	29
◦ Pyrolysis.....	29
◦ Emptying the water tank.....	31
◦ Descaling the boiler.....	32
8 / Anomalies and solutions	33
9 / After-Sales Service.....	34
Suitability for the function	35

IMPORTANT SAFETY INSTRUCTIONS

IMPORTANT SAFETY INSTRUCTIONS - READ CAREFULLY AND RETAIN FOR FUTURE USE.

This user guide is available for download on the brand's website.

When you receive the appliance, unpack it or have it unpacked immediately. Check its general appearance. Make a note of any reservations on the delivery slip and keep a copy.



This appliance must be installed more than 850 mm up off the ground.

— In order to avoid overheating, the appliance must not be installed behind a decorative door.

— Centre the oven in the unit so as to ensure a minimum distance of 10 mm between the appliance and the surrounding unit. The material of the unit supporting the appliance must be heat-resistant (or covered with a heat-resistant material). For greater stability, attach the oven to the unit with 2 screws through the holes provided on the side panels.



It must be possible to disconnect the appliance from the power supply, either using a plug or by fitting a

switch on the fixed wiring system in accordance with installation rules.

— The electrical plug must remain accessible after installation.

— If the power cable is damaged, it should be replaced by the manufacturer, its after-sales service department or by a similarly qualified person in order to avoid danger.

— This appliance is designed to cook with the door closed.

— This appliance may be used by children aged 8 years and older, and by persons with impaired physical sensorial or mental capacities, or without experience or knowledge, if they are supervised or have received prior instructions on how to use the appliance safely and have understood the risks involved.

— Children must not be allowed to play with the appliance. Cleaning and maintenance operations must not be carried out by children without supervision.

IMPORTANT SAFETY INSTRUCTIONS

— Children must be supervised to prevent them from playing with the appliance.



WARNING:

The appliance and its accessible parts become hot during use. Be careful not to touch the heating elements located inside the oven. Children under 8 years old must not be allowed near it unless they are supervised at all times.

— Before pyrolytic cleaning of your oven, remove all accessories and any thick deposits.

— During cleaning, the surfaces may become warmer than under normal conditions of use.

It is advisable to keep children away from the appliance.

— The oven must be turned off when cleaning inside the oven.

scrapers for cleaning the oven's glass door, as they could scratch the surface and cause the glass to shatter.

— Do not use a steam cleaner.

Do not modify the characteristics of this appliance; doing so could be dangerous.

Do not use your oven as a larder or to store any items after use.



WARNING :

Make sure the appliance is disconnected from the power before replacing the lamp in order to avoid the risk of electric shock. Change the lamp only when the appliance has cooled down. To unscrew the view port and the light, use a rubber glove, which will make disassembly easier.

— Do not use abrasive cleaning products or hard metal

• 1 INSTALLATION

CHOICE OF LOCATION AND BUILDING IN

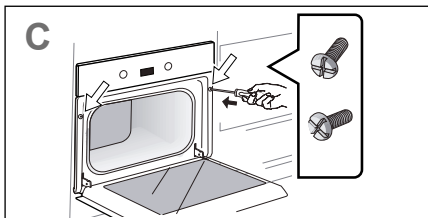
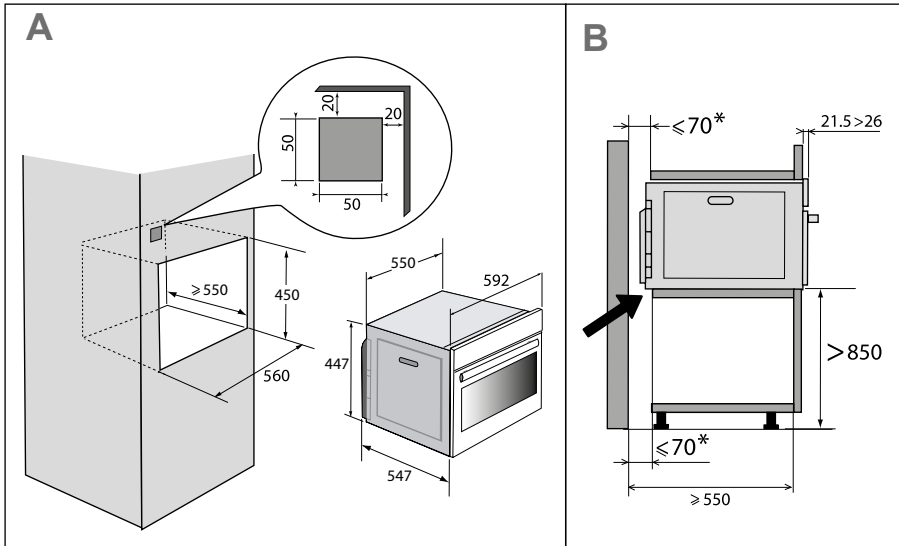

This appliance must be installed more than 850 mm up off the ground. This appliance may be installed in a cabinet column, as indicated on the installation diagram (fig. A).

Caution: if the back of the cabinet is open, the space between the wall and the surface on which the oven rests must be no more than 70 mm* (fig. B).

Do not use your appliance immediately (wait approximately 1 to 2 hours) after moving it from a cold location to a hot location, as the condensation may

cause a malfunction.

Centre the oven in the unit so as to ensure a minimum distance of 10 mm between the appliance and the surrounding unit. The material of the unit supporting the appliance must be heat-resistant (or covered with a heat-resistant material).

Drill a 2 mm diameter hole in the cabinet panel to avoid splitting the wood.

For greater stability, attach the oven to the unit with 2 screws through the holes provided on the side panels (fig. C).

• 1 INSTALLATION

ELECTRICAL CONNECTION



Warning:

Installation should only be performed by installers and qualified technicians.

The appliance must be recess-fitted correctly to ensure electrical safety. The electrical connections should be made before the appliance is installed in its housing.

The oven must be connected via a standardised power cable with 3 conductors of 1.5 mm² (1 live + 1 neutral + earth) which must be connected to the network by means of an IEC 60083 standard power socket or via an all-pole cut-off device in compliance with the installation rules.

Check that:

- the electrical installation has sufficient voltage (220-240 Volts~ 16 Amps),

If the electrical installation in your home requires any changes in order to connect your appliance, contact a professional electrician.

During maintenance operations, the appliance must be unplugged from the electrical grid; fuses must be switched off or removed.



Caution:

The safety wire (green-yellow) is connected to the appliance's terminal and must be connected to the installation's earth.

If the oven malfunctions in any way, unplug the appliance or remove the fuse corresponding to the sector where the oven is hooked up.

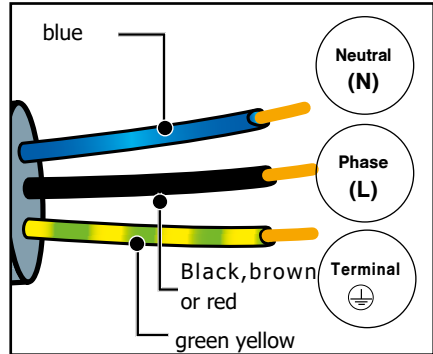

Caution:

We cannot accept liability for any accident or incident resulting from non-existent, defective or incorrect grounding.

• 2 ENVIRONMENT

CARE FOR THE ENVIRONMENT

The packaging of this appliance can be recycled. Help to recycle them and protect the environment by placing them in the municipal containers provided for this purpose.



Your appliance also contains many recyclable materials. It therefore is marked with this symbol to indicate that appliances to be disposed of should not be mixed with other

waste.

This way, the appliance recycling organised by your manufacturer will be done with maximum efficiency, in compliance with European Directive 2002/96/EC on Waste Electrical and Electronic Equipment.

Contact your local authority or retailer for information on used appliance collection points close to your home.

Thank you for co-operation in protecting the environment.

• 3 DESCRIPTION OF THE OVEN

DESCRIPTION OF THE OVEN

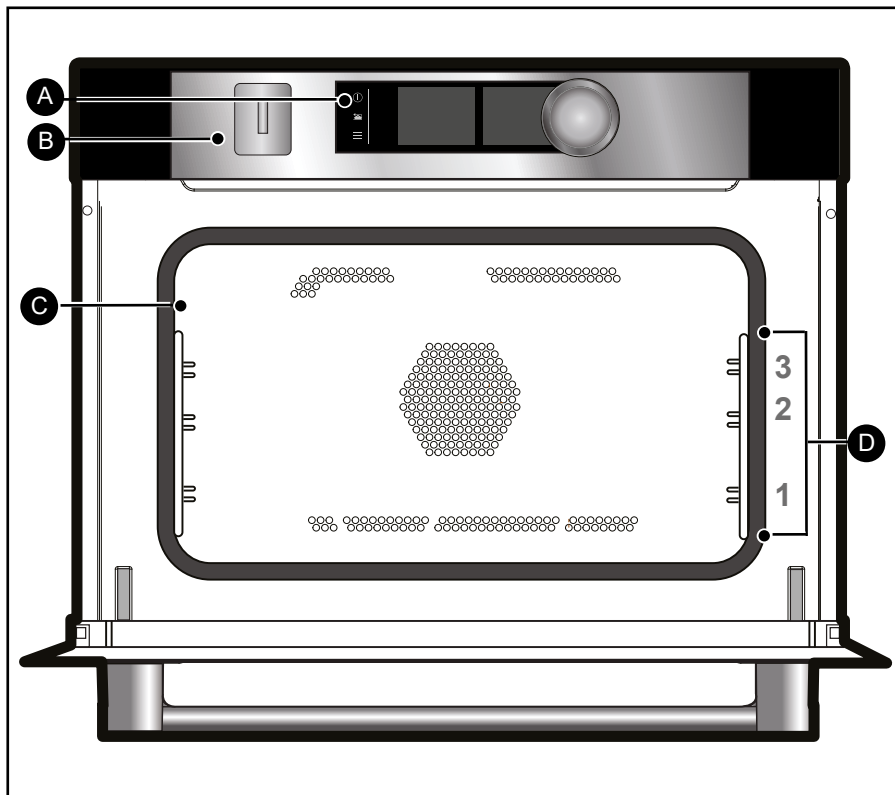

- A Control panel
- B Water tank refill tray
- C Lamp
- D Shelf runners (3 heights available)

• 3 DESCRIPTION OF THE OVEN

THE CONTROLS AND DISPLAY

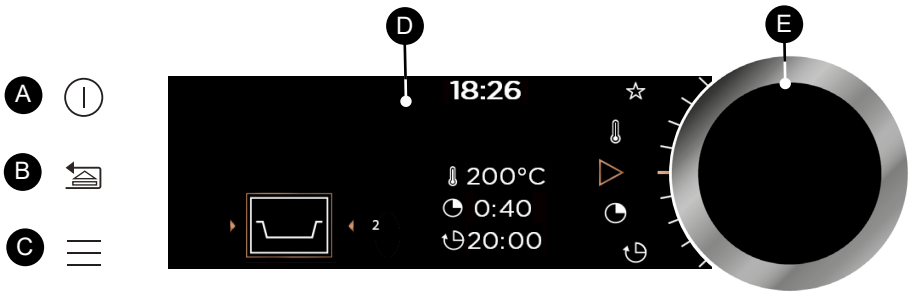

A **Oven off touch control**
(press and hold)

B **Go back touch control**
(press and release) and / or
Tray open key
(press and hold)

C **MENU access touch control**
(cooking, settings, minute
minder, cleaning)

D **Displays**

E **Rotating knob with central button**
(cannot be removed):

- Choose programmes, increase or
reduce values by turning it.

- Validate each action by pressing
the centre.

DISPLAY SYMBOLS

 Start a cooking programme

 Stop a cooking programme

 Temperature degrees

 Cooking time

 Cooking end time
(delayed start function)

 Steam

 Saved cooking
programmes

 Keypad locked indicator

 Door locked indicator
during pyrolysis

 Recommended shelf height indicator
for placing dishes

• 3 DESCRIPTION OF THE OVEN

ACCESSORIES (depending on model)

- Anti-tip safety rack

The rack can be used to support all dishes and moulds containing food for cooking or browning. It can be used for grilling (placed directly on top). Position the anti-tip stop towards the back of the oven.

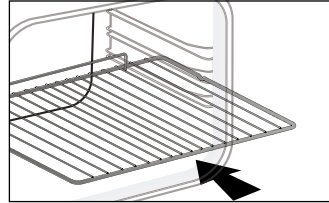

- Multi-purpose tray, drip tray 45 mm

When inserted in the shelf runners under the grill with the handle towards the oven door, it collects juice and fat from grilling, and can be used half-filled with water as a double-boiler.

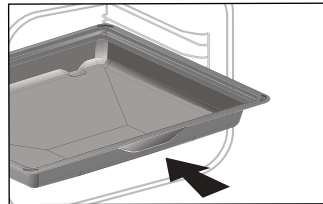

- Special food dish 100% STEAM

1 - Perforated stainless steel cooking dish to prevent contact between food and condensation water.

2 - Multi-purpose tray, drip tray 45 mm for the recovery of condensation water.

Position the perforated stainless steel dish over the multi-purpose tray and insert them on the level 1 shelf runner at the bottom.

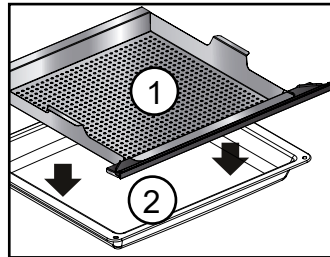

Caution

Use only for the 100% steam cooking function. Do not use with the other cooking modes. Take the dish out of the oven before beginning pyrolytic cleaning.

• 3 DESCRIPTION OF THE OVEN

The refill tray

. Refilling the water tank

Before steam cooking at any time, empty the tank.

The tank volume is 1 litre.

At the start of combined steam cooking, the refill tray opens automatically.

Fill the tank.

Ensure that the tank is filled to its maximum level.

To do this, use the maximum level marker visible on one of the sides of the tray.

After doing this, manually push the tray shut.

Your oven is now ready for combination steam cooking.

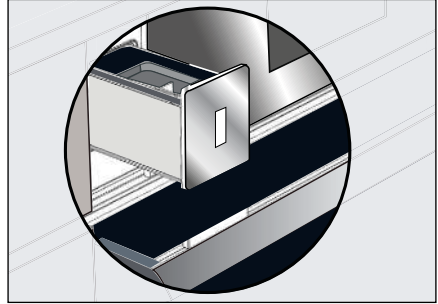

Tip

When filling the tank, it takes a few seconds for the water level to settle. Readjust the level if necessary.

Caution

Do not use softened or demineralised water.

Caution:

Empty the tank every time before cooking. The automatic emptying cycle lasts approximately 3 min. Refer to the “Care - Emptying function” chapter.

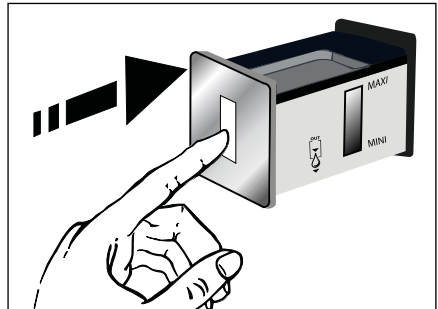

• 3 DESCRIPTION OF THE OVEN

INITIAL SETTINGS - USING THE OVEN FOR THE FIRST TIME

- Select the language

The first time you use your oven or after a power cut, turn the knob to select your language and press to confirm your choice.

- Set the time

The displays flashes 12:00.

Adjust the hours and minutes by turning the knob, then press to confirm.

Your oven displays the time.

Note: To modify the time again, refer to the "Settings" chapter.

 Before using your oven for the first time, heat it at maximum temperature while empty for approximately 30 minutes. Make sure that the room is sufficiently ventilated.

- Starting - General menu



Press the MENU key  to access the general menu when the oven only displays the time.

You will access the first cooking mode: Expert mode.

Turn the knob to scroll through the different programmes:



To enter the selected mode, validate by pressing the knob.

To go back (except during cooking), press the back key  and to stop the oven, press the stop key  for a few seconds.

• 4 COOKING

THE COOKING MODES

Select one of the following modes according to your experience in cooking your recipe:

1



Select “**EXPERT**” mode for a recipe for which you will select the type of cooking, the temperature and the cooking time yourself.

2



Select the “**EXPERT STEAM**” mode for a recipe for which you will select the type of cooking, the temperature, the percentage of steam and the cooking time.

3



Select the “**COOKING GUIDE**” mode for a recipe for which you need assistance from the oven. Simply choose the type of food, enter its weight, and the oven will select the most suitable parameters.

4



Select the “**COOKING GUIDE + STEAM**” mode for a traditional recipe associated with steam or a 100% steam dish for which you need assistance from the oven. Simply select the type of food proposed and its weight and the oven will select the most suitable parameters.

• 4 COOKING



“EXPERT” MODE

This mode lets you set the cooking parameters yourself: temperature, cooking type, cooking time.

When the oven is only displaying the time, press the MENU key  to access the general menu then confirm the “Expert” mode.

- Turn the control knob until you get to the cooking function of your choose, then confirm:



Fan cooking



Combined heat



Traditional



Eco cooking



Grill ventilated



Bottom heat ventilated



Variable grill



Keep warm



Defrost



Bread



Drying



Favourites (enables 3 cooking programmes to be saved)



“EXPERT STEAM” MODE

This cooking mode enables you to obtain more tender and gentler cooking that preserves the flavours. It prevents food from drying up and preserves crispiness (in combined mode).

This function lets you set all the cooking parameters including the percentage of steam.

- Select the “EXPERT STEAM” mode in the general menu and confirm.

Select one of the cooking functions offered among the list below and confirm.

- To cook with steam only:



Steam 100%

- To combine normal cooking with steam (combined mode):



Traditional steam



Grill ventilated + steam



Circulating heat + steam

• 4 COOKING



(Expert and Expert Steam)

IMMEDIATE COOKING

Once you have selected and validated your cooking function, the oven will recommend one or two shelf heights.

- Place your dish in the oven at the recommended level.
- Press the control knob again to start cooking. The temperature starts to increase at once.

Note: Certain parameters may be modified (depending on the mode selected) before cooking starts (temperature, cooking time, percentage of steam and delayed start); see the following chapters.

CHANGING THE TEMPERATURE

Based on the type of cooking you already selected, the oven will recommend the ideal cooking temperature.

This can be adjusted as follows:

- Select the temperature symbol  then confirm.
- Turn the control knob to change the temperature then confirm your choice.

COOKING TIME

You can enter the cooking time for your dish by selecting the cooking time symbol  and confirming.

Enter the cooking time by turning the control knob then confirm.

Your oven has the “SMART ASSIST” function which, when programming a cooking time, will suggest a cooking time which can be modified depending on the selected cooking mode.



The time starts to count down as soon as the cooking temperature is reached.



STEAM PERCENTAGE

(Expert Steam only)

The oven suggests an ideal steam percentage.

To modify this, select the steam symbol  and confirm.

Enter the new steam percentage by turning the knob (between 50 and 100% in steam mode and between 20 and 80% in combined mode) and confirm your selection.

• 4 COOKING



(Expert and Expert Steam)

DELAYED START

When you set the cooking time, the end of cooking time automatically adjusts. You can change the end of cooking time if you want to delay the programme start.

-Select the cooking end symbol  and confirm.

Once you have set the cooking end time, confirm twice.

Note: You may start cooking without selecting a duration or end time. In this case, when you feel that you have cooked your dish for long enough, stop cooking (see the “Stopping cooking in progress” chapter).

STOPPING COOKING IN PROGRESS

To stop a cooking programme in progress, press the control knob.

The oven displays a message: “Do you want to stop the cooking in progress?”.



Confirm by selecting “I agree” then validate or select “I refuse” and validate to continue cooking.



- Memorise a cooking

The “Favourites” function lets you save 3 recipes in “Expert” mode that you make frequently.

In Expert mode, first of all select a cooking, its temperature and its time. Then select the  symbol by turning the control knob to memorise this cooking, then confirm.



The screen then suggests saving these parameters in a memory ,  or . Choose one then confirm. Your cooking is then memorised. Confirm again to start cooking.

NB: If the 3 memories are already used, any new memorisation will replace the previous one.

A delayed start cannot be programmed for memorisations.

- Use a memory that is already saved in the “Favourites” function

Go to the “Expert” menu and confirm. Scroll through the functions to the “Favourites” function by turning the control knob. Confirm.

- Select one of the memories already saved ,  or  and press to confirm.

The oven starts.







• 4 COOKING



EXPERT COOKING FUNCTIONS (depending on model)



Pre-heat your oven empty before cooking.





Position	T°C recommended mini - maxi	Use
 Fan oven*	190°C 35°C - 250°C	Recommended for keeping white meat, fish and vegetables moist.
 Combined heat	180°C 35°C - 230°C	Recommended for meat, fish and vegetables.
 Traditional	200°C 35°C - 275°C	Recommended for meat, fish and vegetables.
 ECO*	190°C 35°C - 275°C	This setting saves energy while maintaining the quality of the cooking. In this setting, pre-heating is not required.
 Grill ventilated	190°C 100°C - 250°C	Roasts and poultry are juicy and crisp all over. Slide the drip tray on to the bottom shelf support. Recommended for all spit-roasted poultry or meat, for sealing and thoroughly cooking a leg or a rib of beef. To retain the moist texture of fish steaks.
 Bottom heat ventilated	180°C 75°C - 250°C	Recommended for meat, fish and vegetables.

*Cooking mode as per standard EN 60350-1: 2016 to demonstrate compliance with requirements of the energy label of European regulation UE/65/2014.



Never place tin foil directly in contact with the oven floor as the build up of heat may damage the enamel.

• 4 COOKING

Position	T°C recommended mini - maxi	Use
 Variable grill	4 1 - 4	Recommended for grilling cutlets, sausages, toasting bread and prawns placed on the grill. Cooking is done by the upper element. The grill covers the entire shelf surface.
 Keep warm	60°C 35°C - 100°C	Recommended to keep dishes warm or warm plates; to raise dough for bread, brioche, kügelhopf, etc. (with mould on the bottom, not exceeding 40°C).
 Defrost	35°C 35°C - 75°C	Ideal for delicate dishes (fruit tarts, custard pies, etc.). Meat, rolls, etc. are defrosted at 50°C (meat should be placed under the grill with a dish underneath to catch the drips).
 Bread	205°C 35°C - 220°C	Recommended cooking sequence for bread making. Pre-heat, then place the ball of dough on a baking sheet on the 2nd shelf support. Do not forget to place a dish of water in the bottom to obtain a crisp, golden crust. A BREAD setting also exists in the STEAM cooking guide.
 Drying	80°C 35°C - 80°C	Sequence to dehydrate certain food such as fruits, vegetables, seeds, roots, seasoning plants and herbs. Refer to the specific drying table below.

 **Advice on how to save energy**
Avoid opening the door during cooking to avoid heat escaping from the oven.

• 4 COOKING



DRYING FUNCTION (Expert mode only)

Drying is one of the oldest methods of preserving food. The aim is to remove all or some of the water in the food to preserve foodstuffs and prevent the development of microbes. Drying preserves the nutritional qualities of food (minerals, proteins and other vitamins). It allows food to be stored in optimal conditions thanks to their reduced size and makes food easy to use once re-hydrated.

Only use fresh food.

Wash the food carefully, drain and wipe.

Cover the grill in parchment paper and distribute the cut food evenly on top.

Use shelf level 1 (if you have several grill pans, put them on levels 1 and 3).

Turn the food over several times during drying. The values provided in the table may vary depending on the type of food to dehydrate, its maturity, its thickness and its humidity rate.

Guide table to dehydrate your food

Fruits, vegetables and herbs	Temperature	Time in hours	Accessories
Fruits with seeds (in 3 mm slices, 200 g per grill pan)	80°C	5-9	1 or 2 grill pans
Fruits with stones (plums)	80°C	8-10	1 or 2 grill pans
Edible roots (carrots, parsnips), grated and blanched	80°C	5-8	1 or 2 grill pans
Sliced mushrooms	60°C	8	1 or 2 grill pans
Tomato, mango, orange, banana	60°C	8	1 or 2 grill pans
Sliced red beetroot	60°C	6	1 or 2 grill pans
Herbs	60°C	6	1 or 2 grill pans

• 4 COOKING



“COOKING GUIDE” MODE



“COOKING GUIDE + STEAM” MODE



COMBINED STEAM



STEAM 100% GUIDE

These two modes select for you the appropriate cooking parameters based on the food to be prepared. These are recipes with or without any steam associated or with 100% steam.

IMMEDIATE COOKING

- Select the “COOKING GUIDE” or “COMBINED STEAM” modes when you are in the general menu then confirm.

The oven suggests several categories which contain a wide range of dishes (see detailed list below):

- Select the category, example “The poulterer”, then confirm.

- Choose the specific dish to be prepared, for example “chicken”, and confirm.

The weight (or size) must be entered for certain food.

- A weight is then suggested. Enter the weight and confirm; the oven will automatically calculate and display the cooking time and the shelf height.

- Place your dish in the oven and confirm.

For certain recipes the oven must be

 **warmed up before you place your disk in it.**

You may open your oven to baste your dish at any time during cooking.

- The oven beeps and turns off when the cooking time is finished; your screen then indicates that the dish is ready.

DELAYED START COOKING

If you wish, you can change the cooking end time by selecting the cooking end symbol  and confirming.

Once you have set the cooking end time, confirm twice.

 **For recipes which require pre-heating, it is not possible to use the delayed start function.**

• 4 COOKING



LIST OF DISHES WITHOUT STEAM (COOKING GUIDE)



THE POULTERER

Chicken
Duck
Duck breast *



THE BUTCHER

Rare shoulder of lamb
Roast beef.
Roast pork
Veal rib *



THE FISHMONGER

Salmon
Trout
Bass
Fish terrine



THE CATERER

Lasagne
Pizza
Quiche



THE GREENGROCER

Potato gratin
Stuffed tomatoes
Jacket potatoes



THE BAKER

Brioche
Bread
Baguettes



THE PASTRY COOK

Fruit pie
Sponge cake
Cupcakes
Crème caramel
Cake
Yoghurt cake
Meringues
Yoghurt
Fruit crumble
Biscuits/cookies

* For these dishes, the oven must be warmed up before you place your disk in it.

 The screen tells you not to insert your dish until the oven has reached its temperature.

A beep sounds to let you know that warm-up is complete; the time starts counting down from this point.

Place your dish in the oven at the shelf level indicated.

• 4 COOKING



LIST OF DISHES WITH STEAM ASSOCIATED (COMBINED STEAM)



THE POULTERER

Chicken
Duck breast *
Duck



THE BUTCHER

Lamb
Roast pork
Roast veal
Pork fillet
Veal fillet



THE FISHMONGER

Cooked fish
Fish terrine
Whole fish
Salmon casserole



THE GREENGROCER

Potatoes au gratin
Stuffed vegetables
Jacket potatoes



THE PASTRY COOK

Sponge cake
Flans / creams
Cake
Cupcakes
Pound cake
Apple cake
Nut cake
Coco flan



THE BAKER

Bread
Baguettes
Pre-cooked bread
Frozen dough
Regenerate yesterday's bread



THE CATERER

Lasagne
Clafoutis
Vegetable confit
Potatoes
Risotto
Fresh meals
Frozen meals



DEFROSTING

Meat
Fish
Bread-Cakes

* For these dishes, the oven must be warmed up before you place your dish in it.



The screen tells you not to insert your dish until the oven has reached its temperature.

A beep sounds to let you know that warm-up is complete; the time starts counting down from this point.

Place your dish in the oven at the shelf level indicated.

• 4 COOKING



LIST OF DISHES



100% STEAM (STEAM GUIDE)



THE GREENGROCER

Cauliflower
Broccoli
Green beans
Sliced carrots
Potatoes
Peas
Leeks
Courgettes
Pumpkin
Artichokes
Asparagus
Celery
Squash
Chard
Spinach
Brussels sprouts



THE BUTCHER

Chicken breast
Turkey scallop
Pork - fillet



THE FISHMONGER

Whole fresh fish
Fresh fish fillets
Mussels
Cockles
Shrimp
Langoustines



In this function, a display indicates at which time you must insert the special 100% steam accessory. Inset it on the 1st level shelf runnet at the bottom.

• 5 *SETTINGS*



SETTINGS FUNCTIONS

In the general menu, select the “SETTINGS” function by turning the control knob and confirm.

Different settings are proposed:

- time, language, sound, demo mode and lamp management.

Select the function you want by turning the control knob and then confirm.

Then set your parameters and confirm them.



Time

Modify the time; validate then modify the minutes and validate again.



Language

Choose your language and confirm.



Sound

Your oven emits sounds when you use the keys. To keep these sounds, select ON, otherwise select OFF to deactivate them and confirm.



DEMO mode

By default, the oven is configured in normal heating mode.

If it is activated in DEMO mode (ON position), the mode for presenting products in stores, your oven will not warm up.

To return it to normal mode, set it to OFF and confirm.



Lamp management

Two setting options are proposed:

Position ON, the light stays on throughout cooking (except in ECO mode).

Position AUTO, the oven light turns off after 90 seconds when cooking.

Choose your position and confirm.





Press the back  or menu  keys once to reactivate the light during cooking.

• 5 *SETTINGS*





LOCKING THE CONTROLS

Child safety lock

Press the back  and menu  keys at the same time until the padlock symbol  displays on the screen.

Control locking is accessible during cooking or when the oven has stopped.

NOTE: only the stop key  remains active.

To unlock the keypad, press the back  and menu  keys at the same time until the padlock  symbol disappears from the screen.

• 6 *MINUTE MINDER*



MINUTE MINDER FUNCTION

This function can only be used when the oven is off.

In the general menu, select the “MINUTE MINDER” function by turning the control knob and confirm.

00:00 is displayed on the screen.

Set the minute minder by turning the knob and then press to confirm. The timer starts.

Once the time has lapsed, there is a sound signal. To stop it, press any key.

Note: You can modify or cancel the minute minder at any time.

To cancel, return to the minute minder menu and set to 00:00.

If you press the control knob during the countdown you will stop the minute minder.

• 7 CARE

CLEANING AND MAINTENANCE:

EXTERNAL SURFACE

Use a window washing product applied to a soft cloth. Do not use abrasive creams or scouring sponges.

REMOVING THE SHELF RUNNERS

Side liners with shelf runners:

Lift the front part of the shelf runner upwards. Press the entire shelf runner and release the front hook from its housing. Then, gently pull the whole of the shelf runner towards you to release the rear hooks from their housing. Pull out the two shelf supports.

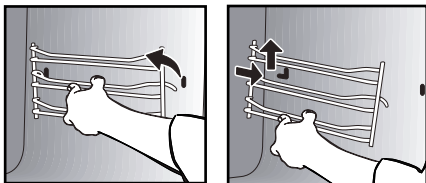

CLEANING THE INNER GLASS

To clean the inner glass, remove the door. Before disassembling the glass, remove any excess grease on the inside glass with a soft cloth and washing up liquid.

Warning
Do not use scouring products, abrasive sponges or metal scrapers to clean the glass oven door as this could scratch the surface and cause the glass to shatter.

REMOVING AND PUTTING BACK THE DOOR

Open the door fully and block it with one of the plastic wedges provided in your appliance's plastic pouch.

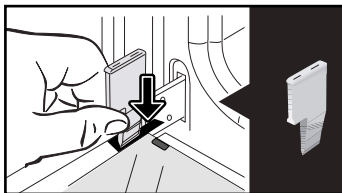

To remove the frame and glass assembly, proceed as follows: Insert the two other red stops in the slots designed for this. **A**

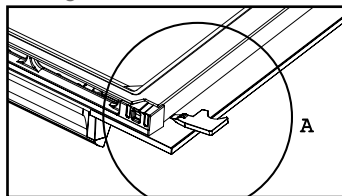

Lever the assembly to detach the frame and the glass.



• 7 CARE

Remove the frame and the glass.
Remove all the door's interior windows by rotating them.



This assembly comprises 2 glass windows, the 1st of which has 2 rubber stops on the 2 front corners.

Clean the glass using a soft sponge and washing-up liquid.

Do not soak the glass panel in water.
Do not use abrasive creams or scouring sponges. Rinse with clean water and dry off with a lint-free cloth.

After cleaning, replace the 1st glass pane in the door.

Reposition the 2 black rubber stops on the front corners of the 2nd pane, making sure the following is indicated on the glass:

Top left: **L**

Top right: **R**

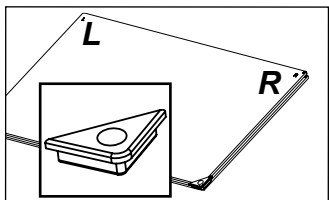

Then replace the door and the 2nd pane, positioning it onto the first.

Place the external glass frame assembly back in the door.

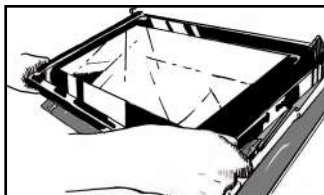

Make sure you correctly slot the frame under the spigot next to the hinge.

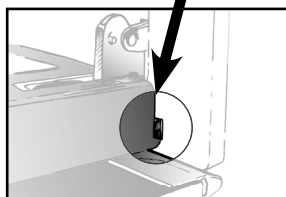
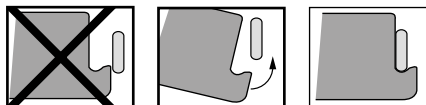

Attach the frame by tightening it with the door. Do not press on the frame alone.

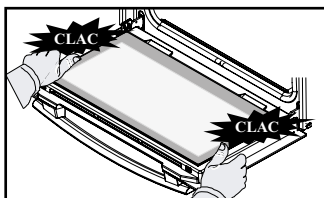

Your appliance is now ready for use again.

• 7 CARE



REPLACING THE LIGHT BULB



Warning
Make sure the appliance is disconnected from the power before replacing the bulb in order to avoid the risk of electric shock. Carry out the operation when the appliance has cooled.

Bulb specification:

25 W, 220-240 V~, 300°C, G9. This product contains a light source of energy efficiency class G.

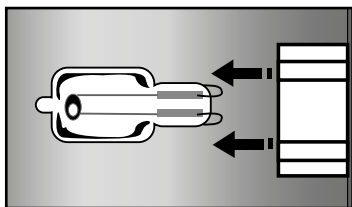
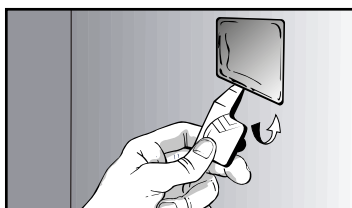

You can replace the bulb yourself. First disassemble the left-hand side shelf support.

The bulb is accessible inside the oven. Use the plastic stop as a lever to remove the glass.

Change the bulb (use a rubber glove to facilitate its removal) then reattach the glass.

Plug your oven back in.



“CLEANING” FUNCTION (the cavity)



Remove the accessories and supports from the oven before beginning pyrolysis cleaning. Before starting a pyrolysis cleaning cycle, make sure that any accessories that are not pyrolysis safe have been removed from the oven (sliding rails, baking trays, chrome-plated grills, and so on) as well as any cookware.

PYROLYSIS CLEANING

This oven is equipped with a pyrolysis cleaning function:

Pyrolysis is a cycle during which the oven cavity is heated to a very high temperature in order to eliminate soiling from splattering and spills.

Before starting pyrolysis cleaning, remove any large overspills, if any. Remove the excess grease on the door using a damp sponge.

As a safety measure, cleaning only occurs after the door locks automatically; it is impossible to unlock the door.

• 7 CARE

PROGRAMMING A PYROLYSIS CLEANING CYCLE

Two pyrolysis cycles are available. The durations are pre-selected and cannot be modified:



Pyro ECO: in 1h30

for cleaning to save energy.



Turbo Pyro: in 2:00

for more in-depth cleaning of the inside of the oven.

IMMEDIATE CLEANING

- Select the “CLEANING” function when you are in the general menu then confirm.
- Select the most suitable self cleaning cycle, for example Turbo Pyro, and confirm.

The pyrolysis cycle begins. The time starts to count down immediately it is set. During pyrolysis, the symbol  displays in the programmer to indicate that the door is locked.

At the end of the pyrolysis cycle, 0:00 flashes.

A cooling phase occurs after each pyrolysis and your oven remains unavailable during this time.

 **When the oven is cool, use a damp cloth to remove the white ashes. The oven is clean again and ready for further cooking operations.**

SELF CLEANING WITH DELAYED START

Follow the instructions described in the previous section.

- Select the end time symbol (delayed start)  and confirm.

- Set the pyrolysis end time you want with the control knob and confirm twice. After these steps, the oven switches to standby and the start of pyrolysis is delayed so that it finishes at the programmed time.

When the pyrolysis is complete, switch your oven off by pressing the  key.



EMPTYING FUNCTION (water tank)



Empty the tank every time before cooking.

Emptying may also be carried out when not cooking.

- To do so, select the “CLEANING” function when you are in the general menu then confirm.
- Select the “Emptying” cycle and confirm. The tray opens.
- Select one of the 2 emptying modes, SPEED or AUTO (see detail below) and proceed in the same way as an automatic emptying cycle once finished cooking.

Automatic emptying after cooking:

Every time you finish cooking with your combination steam oven, you will be asked if you wish to empty the tank.

You may choose not to empty the tank by selected “I refuse”, otherwise select “I accept” and confirm.

Select a SPEED or AUTO emptying cycle and confirm.

The tray will open automatically to be emptied.



SPEED emptying:

Only if the user wants to use the combination steam oven again immediately.

Emptying time: approximately 20 seconds.



AUTO emptying:

This fully empties the boiler and the tank to avoid stagnant water.

Emptying time: approximately 2 to 3 minutes.

Place a sufficiently large container (minimum 1 litre) under the tray in order to receive the water.

Confirm by pressing the knob to start emptying.

The emptying time displays on the screen.

Once the emptying finished, the screen will indicate 0 m 0 s. Close the tray manually.



DESCALING FUNCTION (steam boiler)

Descaling is a cleaning cycle which eliminates limescale from the boiler.

You must regularly descale the boiler. When the oven suggests “descaling recommended” you may decide not to do it by selecting “I refuse” and confirm. You will be able to cook 5 more times before the “combination steam” functions are no longer effective. However, if the message “descaling compulsory” appears, you must descale the boiler and select “I accept” and confirm.



Caution:
When the display indicates “Descaling compulsory”, you must imperatively descale the boiler.

To do so, select the “CLEANING” function when you are in the general menu then confirm.

- Select the “Descale” cycle and confirm. The tray opens automatically.

Proceed step by step.

PHASE 1: EMPTYING

Place a sufficiently large container (minimum 1 litre) under the tray in order to receive the water and confirm.

- The “Emptying” cycle starts and lasts for 3 min 30 s.

PHASE 2: CLEANING

- Pour 110 ml of pure white vinegar in the tank.

- Close the tray manually. The “Cleaning” cycle starts and lasts for 30 min. at the end of the cycle the tray opens automatically.

PHASE 3: RINSING

Fill the tank with water to the MAX level.

- Place a container underneath the tray and confirm.

- The “Rinsing” cycle starts and lasts for 3 min 30 s.

PHASE 4: EMPTYING

A second rinsing cycle is required; refill the water tank up to the MAX level.

- Place a container underneath the tray and confirm.

- The “Emptying” cycle starts and lasts for 3 min 30 s.

At the end of the cycle, the descaling is complete.

A beep sounds. Close the tray manually. Your oven is now ready for use again.

• 8 *ANOMALIES AND SOLUTIONS*



- **“Auto Stop” displays.** This function stops heating the oven if you forget to switch it off. Turn your oven to STOP.
- **Default code starting with “F”.** Your oven has detected a problem. Stop the oven for 30 minutes. If the fault is still there, cut off the power supply for at least one minute. If the fault persists, contact the Customer Service Department.
- **The oven is not heating.** Check that the oven is correctly connected and that your installation’s fuse is not out of service. Check that the oven is not set to “DEMO” mode (see settings menu).
- **The oven light is not working.** Replace your installation’s bulb or fuse. Check that the oven is correctly connected.
- **The cooling fan continues to operate after the oven stops.** This is normal. It can work for up to one hour after cooking to cool down the oven. If it continues beyond this, contact the Customer Service Department.
- **The pyrolysis cleaning cycle does not begin.** Verify that the door is locked. Call the Customer Services Department if the problem persists.
- **The “door locking” symbol flashes in the display.** Door locking fault. Contact the Customer Services Department.
- **There is water on the floor of the oven.**
 - The boiler is scaled. Follow the DESCALING procedure. If the fault persists, call the After-Sales Service.

• 9 AFTER-SALES SERVICE

INTERVENTIONS

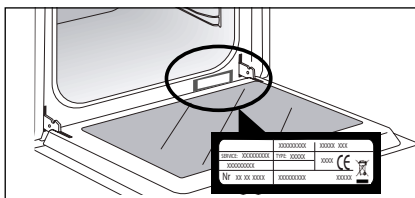
Any repairs to your appliance must be made by a qualified professional accredited to work on the brand. When calling, please provide the full references of your appliance (commercial reference, service reference, serial number), so that we can handle your call better. This information appears on the manufacturer's nameplate on the equipment.



A	B	G
SERVICE: C	TYPE: D	I  
E	F	
Nr H		Made in France 

- B: Commercial reference
- C: Service reference
- H: Serial number

NOTE:

- With a view to constantly improving our products, we reserve the right to make changes to their technical, functional or aesthetic characteristics in line with technological progress.
- Make a note here of the references on your appliance, so that you can readily find them in future.

**FUNCTIONAL SUITABILITY TESTS IN ACCORDANCE
WITH EN 60350:**

Test	Cooking sequence	T°C	Shelf position	Time	Observations
Cookies (8.4.1)	Convection	165	2	18-20 min	Pastry tray
	Tradition	200	2	20-23 min	Lissium pastry tray
	Convection	165	3 / 1	22-25 min	Preheated oven: -Pastry tray -Enamel plate
Small Pastries (8.4.2)	Convection	165	2	22-25 min	Pastry tray
	Convection	160	3 / 1	22 min	Preheated oven: -Pastry tray -Enamel plate
Savoy sponge (8.5.1)	Convection	170	1	35-40 min	Preheated oven, mould on the grid + 5 min in switched off oven without preheating
	Tradition	175	1	45 min	2 levels, (not applicable)
Apple tart (8.5.2)	Combined	180	1	50-55 min	20 cm mould on the grid
	Convection	180	3 / 1	50-55 min	Preheated oven: -Enamel plate on 1st level
Surface grill (9.1)	High grill	P4	2	2-3 min	Preheat 5 minutes Bread on grid with the door closed