

DOP7574

FR GUIDE D'UTILISATION
EN USER GUIDE
ES GUÍA DE UTILIZACIÓN
NL GEBRUIKSGIDS
PT GUIA DE UTILIZAÇÃO

FOUR

OVEN
FORNO
OVEN
HORNO

De Dietrich 

DEAR CUSTOMER, CUSTOMER,

Discovering a De Dietrich product means experiencing the range of unique emotions.
The attraction is immediate, from the moment you set eyes on the product.
The sheer quality of the design shines through, thanks to the timeless style and outstanding finishes which make each component an elegant and refined masterpiece in its own right, each one in perfect harmony with the others. Next, comes the irresistible urge to touch it.
De Dietrich design makes extensive use of robust and prestigious materials, where the accent is placed firmly upon authenticity. By combining state-of-the-art technology with top quality materials, De Dietrich produces beautifully crafted products to help you get the most from the culinary arts, a passion shared by all lovers of cooking and fine food. We hope that you enjoy using this new appliance.
Thank you for choosing a De Dietrich product.

De Dietrich 

CONTENTS

1 / Description of the oven	4
The controls and display	5
The accessories.....	6
Initial settings - using the oven for the first time.....	8
2 / The cooking modes	9
«Expert» mode	9
◦ Cooking functions.....	10
◦ Drying.....	13
◦ Favourites (saved cooking)	14
«Recipes» mode	14
«Chef» mode	16
«Low temperature» mode	18
3 / Settings	20
◦ Time	20
◦ Language	20
◦ Sound.....	20
◦ Demo mode	20
◦ Lamp management	20
Locking the controls.....	21
4 / Minute Minder	21
5 / Cleaning and Maintenance	22
External surface.....	22
Removing the shelf runners.....	22
Cleaning the inner glass	22
Removing and putting back the door.....	22
Cleaning function (pyrolysis)	24
Replacing the light bulb	25
6 / Anomalies and solutions	26
7 / After-Sales Service	27

• 1 DESCRIPTION OF THE OVEN

DESCRIPTION OF THE OVEN

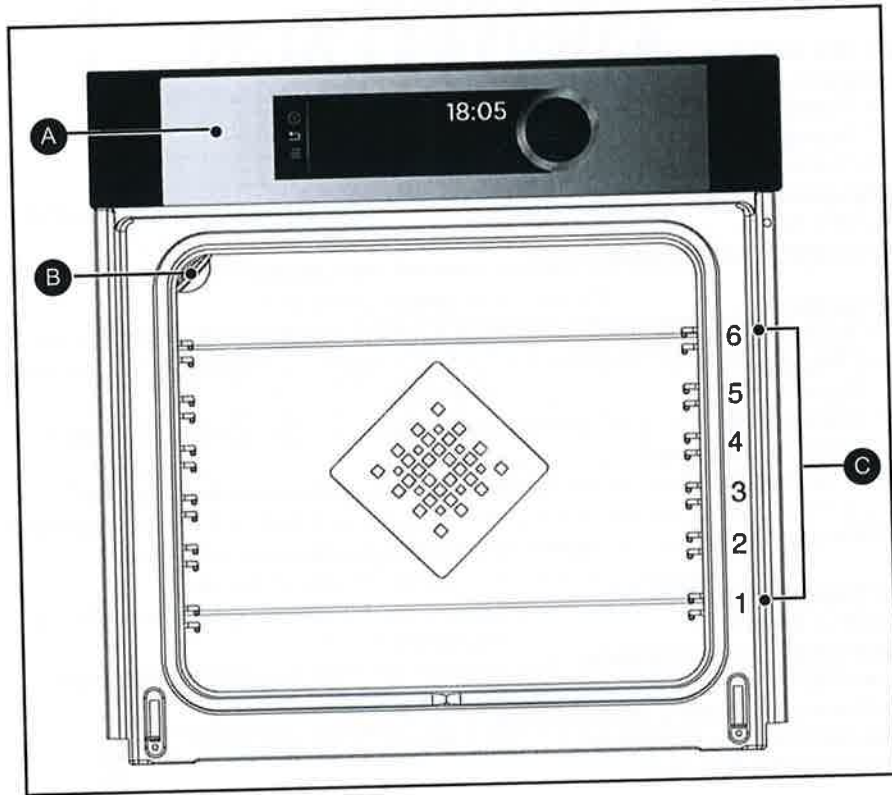



- A** Control panel
- B** Lamp
- C** Shelf runners (6 heights available)



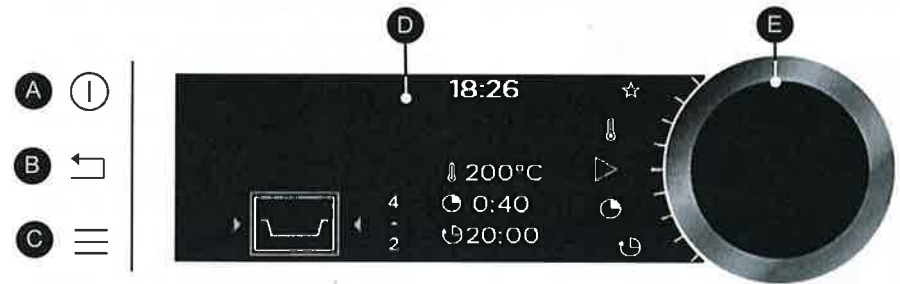





• 1 DESCRIPTION OF THE OVEN

THE CONTROLS AND DISPLAY



- A**  **Oven off touch control**
(press and hold)
- B**  **Go back touch control**
(active in programming search, not cooking)
- C**  **MENU access touch control**
(cooking, settings, minute minder, cleaning)
- D** **Displays**
- E** **Rotating knob with central button**
(cannot be removed):
 - Choose programmes, increase or reduce values by turning it.
 - Validate each action by pressing the centre.

DISPLAY SYMBOLS

-  Start a cooking programme
 -  Stop a cooking programme
 -  Temperature degrees
 -  Cooking time
 -  Cooking end time
(delayed start function)
 -  Saved cooking programmes
 -  Keypad locked indicator
 -  Door locked indicator during pyrolysis
-  Recommended shelf height indicator for placing dishes.

• 1 DESCRIPTION OF THE OVEN

ACCESSORIES (depending on model)

- Anti-tip safety rack

The rack can be used to support all dishes and moulds containing food for cooking or browning. It can be used for grilling (placed directly on top). Position the anti-tip stop towards the back of the oven.

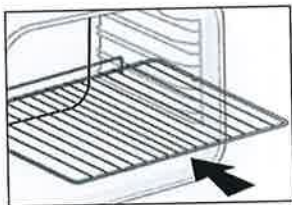

Multi-purpose tray, drip tray 45 mm

When inserted in the shelf runners under the grill with the handle towards the oven door, it collects juice and fat from grilling, and can be used half-filled with water as a double-boiler.



- 20 mm pastry dish

Insert in the shelf runners with the handle towards the oven door. Ideal for baking cookies, shortbread and cupcakes. The tilted surface makes it easier for you to put your preparations in a dish. Can also be inserted into the shelf runners under the grill to collect juice and fat from grilling.

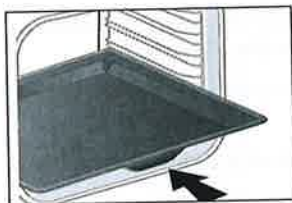

- «Flavour» grills

These half «flavour» grills are used separately, but only when placed in one of the dishes or drip tray with the anti-tip handle towards the back of the oven. By using just one grill, it is easy to moisten your food with the cooking juices collected in the dish.

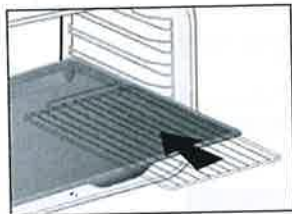

• 1 DESCRIPTION OF THE OVEN

- Sliding rail system

The new sliding rail system makes food more practical and easier to handle as the trays can be effortlessly pulled for simpler handling. The trays can be completely removed, providing full access. Their stability ensures that food can be handled safely, reducing the risk of burns. This means that you can take food out of the oven far more easily.

INSTALLING AND REMOVING THE SLIDING RAILS

After removing the 2 shelf runners, choose the height (2 to 5) at which you want to fit your rails. Snap the left rail against the left shelf runner by applying enough pressure to the front and back of the rail so that the 2 tabs on the side of the rail slot into the shelf runner. Do the same for the right-hand rail.

NOTE: the telescopic sliding part of the rail must unfold towards the front of the oven, with the buffer (A) opposite you.

Insert your 2 shelf runners and then put your tray on the 2 rails. The system is now ready to use.

To remove the rails, remove the shelf runners again.

Slightly prise apart the bottom of the tabs fixed on each rail to release the shelf runner. Pull the rail towards you.

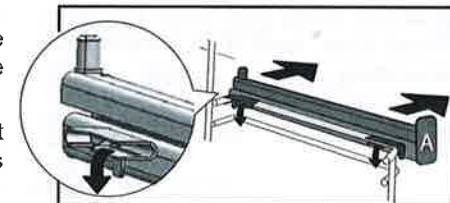
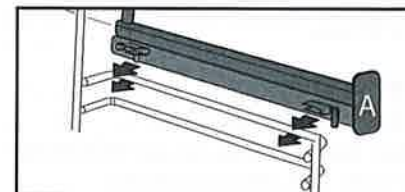
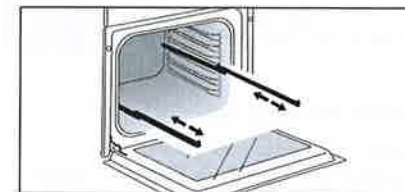

 **Tip**
To avoid fumes when cooking fatty meats, we recommend you add a small amount of water or oil to the bottom of the drip pan.

 **The accessories may warp with the effect of heat, but this will not alter their function. They will return to their original shape once cooled.**

• 1 DESCRIPTION OF THE OVEN

INITIAL SETTINGS - USING THE OVEN FOR THE FIRST TIME

- Select the language

The first time you use your oven or after a power cut, turn the knob to select your language and press to confirm your choice.

- Set the time

The displays flashes 12:00.

Adjust the hours and minutes by turning the knob, then press to confirm.

Your oven displays the time.

Note: To modify the time again, refer to the «Settings» chapter.

Note: To modify the time again, refer to the «Settings» chapter.

 Before using your oven for the first time, heat it at maximum temperature while empty for approximately 30 minutes. Make sure that the room is sufficiently ventilated.

- Starting - General menu



Press the MENU key  key to access the general menu when the oven only displays the time.

You will access the first cooking mode: Expert mode.

Turn the knob to scroll through the different programmes :



To enter the selected mode, validate by pressing the knob.

To go back (except during cooking), press the back key  and to stop the oven, press the stop key  for a few seconds. ..

• 2 COOKING

THE COOKING MODES

Select one of the following modes according to your experience in cooking your recipe:

 1 Select "EXPERT" mode for a recipe for which you will select the type of cooking, the temperature and the cooking time yourself.

 2 Select «RECIPES» mode for a recipe for which you need assistance from the oven. Simply select the type of food proposed and its weight and the oven will select the most suitable parameters.

 3 Select "CHEF" mode for a recipe managed automatically by the oven. Select the dish you want to cook from a list of the most common dishes.

 4 Select "LOW TEMPERATURE" mode for a recipe managed completely by the oven using a specific electronic programme (slow cooking).















«EXPERT» MODE

This mode lets you set the cooking parameters yourself: temperature, cooking type, cooking time.

When the oven is only displaying the time, press the MENU key  to access the general menu then confirm «Expert» mode.

- Turn the control knob until you get to the cooking function of your choose, then confirm:

-  Fan cooking
-  Combined heat
-  Traditional
-  Eco cooking
-  Grill ventilated
-  Bottom heat ventilated
-  Variable grill
-  Keep warm
-  Defrost
-  Bread
-  Drying
-  Shabbat (special function)







 Favourites (enables 3 cooking programmes to be saved)

• 2 COOKING



COOKING FUNCTIONS (depending on model)







 Pre-heat your oven empty before cooking.

Position	T°C recommended mini - maxi	Use
 Fan cooking*	180°C 35°C - 250°C	Recommended for keeping white meat, fish and vegetables moist. For cooking multiple items on up to three levels.
 Combined heat	205°C 35°C - 230°C	Recommended for meat, fish, vegetables, preferably in an earthenware dish.
 Traditional	200°C 35°C - 275°C	Recommended for meat, fish, vegetables, preferably in an earthenware dish.
 ECO*	200°C 35°C - 275°C	This setting saves energy while maintaining the quality of the cooking. In this setting, pre-heating is not required.
 Grill ventilated	200°C 100°C - 250°C	Roasts and poultry are juicy and crisp all over. Slide the drip tray on to the bottom shelf support. Recommended for all spit-roasted poultry or meat, for sealing and thoroughly cooking a leg or a rib of beef. To retain the moist texture of fish steaks.
 Bottom heat ventilated	180°C 75°C - 250°C	Recommended for meat, fish, vegetables, preferably in an earthenware dish.

*Cooking mode as per standard EN 60350-1: 2016 to demonstrate compliance with requirements of the energy label of European regulation UE/65/2014.

 Never place tin foil directly in contact with the oven floor as the build up of heat may damage the enamel.

• 2 COOKING

Position	T°C recommended mini - maxi	Use
 Variable grill	4 1 - 4	Recommended for grilling cutlets, sausages, toasting bread and prawns placed on the grill. Cooking is done by the upper element. The grill covers the entire shelf surface.
 Keep warm	60°C 35°C - 100°C	Recommended for letting dough rise for bread, brioche, kügelhopf. Put the mould on the bottom, not exceeding 40°C (plate-warming, defrosting).
 Defrost	35°C 30°C - 50°C	Ideal for delicate dishes (fruit tarts, custard pies, etc.). Meat, rolls, etc. are defrosted at 50°C (meat should be placed under the grill with a dish underneath to catch the drips).
 Bread	205°C 35°C - 220°C	Recommended cooking sequence for bread making. Pre-heat, then place the ball of dough on a baking sheet - 2nd shelf. Do not forget to place a dish of water in the bottom to obtain a crisp, golden crust.
 Drying	80°C 35°C - 80°C	Sequence to dehydrate certain food such as fruits, vegetables, seeds, roots, seasoning plants and herbs. Refer to the specific drying table below.
 Shabbat	90°C	Special sequence: the oven operates uninterrupted for 25 or 75 hours at 90°C only.

 Advice on how to save energy
Avoid opening the door during cooking to avoid heat escaping from the oven.

• 2 COOKING



IMMEDIATE COOKING (Expert mode)

When you have selected and validated your cooking function, example: Bottom heat ventilated, the oven recommends one or two shelf heights.

- Place your dish in the oven at the recommended level.
- Press the control knob again to start cooking. The temperature starts to increase at once.

Note: Certain parameters may be modified before cooking starts (temperature, cooking time and delayed start); see the following chapters.

CHANGING THE TEMPERATURE

Based on the type of cooking you already selected, the oven will recommend the ideal cooking temperature.

This can be adjusted as follows:

- Select the temperature symbol  then confirm.
- Turn the control knob to change the temperature then confirm your choice.

COOKING TIME

You can enter the cooking time for your dish by selecting the cooking time symbol  and confirming. Enter the cooking time by turning the control knob then confirm.

Your oven has the "SMART ASSIST" function which, when programming a

cooking time, will suggest a cooking time which can be modified depending on the selected cooking mode.

The time starts to count down as soon as the cooking temperature is reached.

DELAYED START COOKING

When you set the cooking time, the end of cooking time automatically adjusts. You can change the end of cooking time if you want to delay the programme start.

-Select the end of cooking symbol  and confirm.

Once you have set the cooking end time, confirm.

Note: You may start cooking without selecting a duration or end time. In this case, when you feel that you have cooked your dish for long enough, stop cooking (see the «Stopping cooking in progress» chapter).

STOPPING COOKING IN PROGRESS

To stop a cooking programme in progress, press the control knob.

The oven displays a message:

«Do you want to stop the cooking in progress?».

Confirm by selecting «I agree» then validate or select «I refuse» and validate to continue cooking.

• 2 COOKING



DRYING FUNCTION

Drying is one of the oldest methods of preserving food. The aim is to remove all or some of the water in the food to preserve foodstuffs and prevent the development of microbes. Drying preserves the nutritional qualities of food (minerals, proteins and other vitamins). It allows food to be stored in optimal conditions thanks to their reduced size and makes food easy to use once re-hydrated.

Only use fresh food.

Wash the food carefully, drain and wipe.

Cover the grill in parchment paper and distribute the cut food evenly on top.

Use shelf level 1 (if you have several grill pans, put them on levels 1 and 3).

Turn the food over several times during drying. The values provided in the table may vary depending on the type of food to dehydrate, its maturity, its thickness and its humidity rate.

Guide table to dehydrate your food

Fruits, vegetables and herbs	Temperature	Time in hours	Accessories
Fruits with seeds (in 3 mm slices, 200 g per grill pan)	80°C	5-9	1 or 2 grill pans
Fruits with stones (plums)	80°C	8-10	1 or 2 grill pans
Edible roots (carrots, parsnips), grated and blanched	80°C	5-8	1 or 2 grill pans
Sliced mushrooms	60°C	8	1 or 2 grill pans
Tomato, mango, orange, banana	60°C	8	1 or 2 grill pans
Sliced red beetroot	60°C	6	1 or 2 grill pans
Herbs	60°C	6	1 or 2 grill pans



• 2 COOKING

FAVOURITES (in Expert mode)

- Memorise a cooking

The «Favourites» function lets you save 3 recipes in «Expert» mode that you make frequently.

In Expert mode, first of all select a cooking, its temperature and its time. Then select the  symbol by turning the control knob to memorise this cooking, then validate.



The screen then suggests saving these parameters in a memory ,  or . Choose one then confirm. Your cooking is then memorised. Confirm again to start cooking.

NB: If the 3 memories are already used, any new memorisation will replace the previous one.

A delayed start cannot be programmed for memorisations.

- Use a memory that is already saved in the «Favourites» function

Go to the «Expert» menu and confirm. Scroll through the functions to the «Favourites  » function by turning the control knob.

- Select one of the memories already saved ,  or  and press to confirm.

The oven starts.

«RECIPES» MODE

This mode selects for you the appropriate cooking parameters based on the food to be prepared.

IMMEDIATE COOKING

- Select «RECIPES» mode when you are in the general menu then confirm.

The oven suggests several categories which contain a range of dishes (see detailed list below):

- Select the category, example «The fishmonger», then confirm.

- Choose the specific dish to be prepared, for example «trout», and confirm.

The weight (or size) must be entered for certain food.

- A weight is then suggested. Enter the weight and confirm; the oven will automatically calculate and display the cooking time and the shelf height.

- Place your dish in the oven and confirm.

 **For certain recipes the oven must be warmed up before you place your disk in it.**

You may open your oven to baste your dish at any time during cooking.

- The oven beeps and turns off when the cooking time is finished; your screen then indicates that the dish is ready.

• 2 COOKING

LIST OF DISHES

THE POULTERER

Chicken
Duck
Duck breast *
Turkey

THE BUTCHER

Rare shoulder of lamb
Rare beef
Beef medium done
Well-cooked beef
Roast pork
Roast veal
Veal rib *

THE FISHMONGER

Salmon
Trout
Fish terrine

THE CATERER

Lasagne
Pizza
Quiche

THE GREENGROCER

Potato gratin
Stuffed tomatoes
Jacket potatoes

THE BAKER

Puff pastry
Shortcrust pastry
Leavened dough
Brioche
Bread
Baguettes

THE PASTRY COOK

Fruit pie
Crumble
Sponge cake
Cupcakes
Crème caramel
Chocolate cake
Short bread / Cookies *
Cake
Yoghurt cake

*** For these dishes, the oven must be warmed up before you place your disk in it.**

 The screen tells you not to insert your dish until the oven has reached its temperature.

A beep sounds to let you know that warm-up is complete; the time starts counting down from this point.

Place your dish in the oven at the shelf level indicated.

DELAYED START COOKING

If you wish, you can change the cooking end time by selecting the end of cooking  symbol and confirming.

Once you have set the cooking end time, confirm.

 **For recipes which require pre-heating, it is not possible to use the delayed start function.**

• 2 COOKING



«CHEF» MODE

This mode will completely simplify cooking for you because the oven will automatically calculate all the cooking parameters (temperature, cooking time, cooking mode) based on the selected dish thanks to its electronic sensors located in the oven that constantly measure the moisture level and temperature variations.

⚠ No preheating is required when using the «CHEF» mode. Cooking ABSOLUTELY must begin in a cool oven.

IMMEDIATE COOKING

- In the general menu, select «CHEF» cooking mode with the control knob and confirm.

The oven proposes a choice of dishes (see the list of dishes below).
- Select your dish and confirm.
- Confirm with the control knob again to start cooking.

⚠ CAUTION:

This cooking mode takes place in two phases:

1- A first information gathering phase during which the oven starts heating and determines the ideal cooking time. This phase lasts between 5 and 40 minutes depending on the dish.

⚠ IMPORTANT: do not open the door during this phase or you may disturb the recording of data and the cooking will be cancelled.

This information gathering phase is represented by an animation ◊◊◊◆◊◊◊.

2- A second cooking phase: the oven has adjusted the time needed and the animation disappears.

The remaining cooking time indicated takes into account the cooking time from the first phase.

You can now open the door, to baste a roast or turn over your meat.

- The oven turns off when the cooking time is over and your screen then indicates that the dish is ready.

DELAYED START COOKING

You can change the cooking finish time before putting your dish into the oven at the recommended shelf level.

To program a delayed start,
- Select the cooking end symbol , change the cooking end time and confirm.

• 2 COOKING



LIST OF DISHES



Pizza

Store-bought pizza - fresh pasta
Ready-to-use pizza dough
Home-made pizza dough
Frozen pizza

Place it on the grill for a crispy crust (you can place a sheet of parchment paper between the grid and the pizza to protect the oven from cheese drippings). Place the pizza on the baking tray for a soft crust.



Roast pork

Loin
Tenderloin

Use an earthenware dish. Add one to two tablespoons of water.
At the end of cooking, allow the meat to sit for 7 to 10 minutes wrapped in a sheet of aluminium foil before carving. Add salt when cooking is finished.



Roast beef (3 cooking modes):

• Beef rare



• Beef medium



• Beef well done



Trim away as much fat as possible: it causes smoke.

At the end of cooking, allow the meat to sit for 7 to 10 minutes wrapped in a sheet of aluminium foil before carving. Place the roast on the grill using the grill + drip tray assembly.



Chicken

Chickens weighing 1 to 1.7 kg
Duck, guinea fowl

Cooking in a dish: opt for earthenware dishes to avoid splattering. Pierce the skin of poultry to avoid splattering.



Fish

Whole fish (bream, hake, trout, mackerel)
Roast fish

Use this function only for whole fish cooked with herbs and white wine.

• 2 COOKING



LIST OF DISHES



Savoury tart

Fresh quiches
Frozen quiches

Use a non-stick aluminium mould: the crust will be crispy on the bottom. Remove the tray from frozen quiches before placing them on the grid.



Cake

Home-style cakes: cake (savoury, sweet), pound cake
Ready-to-mix batters in packets.

Cakes made in a cake mould, round, square and always placed on the grill. It is possible to place 2 cake moulds side by side.



«LOW TEMPERATURE» mode

This cooking mode makes meat fibres tender thanks to **slow cooking** at low temperature.
Cooking quality is optimal.

⚠ No preheating is required when using LOW TEMPERATURE mode. Cooking ABSOLUTELY must begin in a cool oven.

⚠ Cooking at low temperature requires food to be extremely fresh. For poultry, it is important to rinse the outside and inside with cold water and to dry with absorbent paper before cooking.

IMMEDIATE COOKING

- In the general menu, select «Low Temperature» cooking mode with the control knob and confirm your choice. The oven proposes a choice of dishes (see the list of dishes below).

- Select your dish.

- Once you have selected your dish for example: roast veal, put your meat on the grill pan in the upper level (No. 2) and slide the drip pan onto the shelf below (No. 1).

- Confirm the selection by pressing the control knob. Cooking starts.

• 2 COOKING

When cooking is complete, the oven switches off automatically and a signal sounds.

Press the stop key ①.

DELAYED START COOKING

You can choose a delayed «low temperature» start.

Once you have selected your programme, select the cooking end symbol . The display flashes; set the cooking end time by turning the knob then confirm.

The cooking end time display stops flashing.



LIST OF DISHES



Roast veal (4h00)



Roast beef:



rare (3h00)



well done (4h00)



Roast pork (5h00)



Lamb:



rare (3h00)



well done (4h00)



Chicken (6h00)



Small fish (1h20)



Large fish (2h10)



Yoghurts (3h00)



NOTE: Do not use the grill for the following programmes: small fish - large fish and yoghurts.

Put them directly on the drip tray on the shelf level shown on the screen.

• 3 SETTINGS



SETTINGS FUNCTIONS

In the general menu, select the «SETTINGS» function by turning the control knob and confirm.

Different settings are proposed:

- **The time, the language, the sound, demo mode, lamp management.**

Select the function you want by turning the control knob and then confirm. Then set your parameters and confirm them.



Time

Modify the time; validate then modify the minutes and validate again.



Language

Choose your language and confirm.



Sound

Your oven emits sounds when you use the keys. To keep these sounds, select ON, otherwise select OFF to deactivate them and confirm.



DEMO mode

By default, the oven is configured in normal heating mode.

If it is activated in DEMO mode (ON position), the mode for presenting products in stores, your oven will not warm up.

To return it to normal mode, set it to OFF

and confirm.



Lamp management

Two setting options are proposed:

Position ON, the light stays on throughout cooking (except in ECO mode).

Position AUTO, the oven light turns off after 90 seconds when cooking.

Choose your position and confirm.

⚠ After 90 seconds without any action by the user, the display brightness decreases to limit energy consumption and the oven light goes off (when it is in «AUTO» mode).

Press the back ↵ or menu ≡ keys once to restore the display's brightness and activate the light during cooking if necessary.

• 3 SETTINGS



LOCKING THE CONTROLS

Child safety lock

Press the back ↵ and menu ≡ keys at the same time until the padlock symbol  is displayed on the screen.

Control locking is accessible during cooking or when the oven has stopped.

NOTE: only the Ⓞ key remains active.

To unlock the keypad, press the back ↵ and menu ≡ keys at the same time until the padlock  symbol disappears from the screen.

• 4 MINUTE MINDER



MINUTE MINDER FUNCTION

This function can only be used when the oven is off.

In the general menu, select the «MINUTE MINDER» function by turning the control knob and confirm.

00:00 is displayed on the screen.

Set the minute minder by turning the knob and then press to confirm. The timer starts.

Once the time has lapsed, there is a sound signal. To stop it, press any key.

Note: You can modify or cancel the

minute minder at any time. To cancel, return to the minute minder menu and set to 00:00. If you press the control knob during the countdown you will stop the minute minder.

• 5 CARE

CLEANING AND MAINTENANCE:

EXTERNAL SURFACE

Use a window washing product applied to a soft cloth. Do not use abrasive creams or scouring sponges.

REMOVING THE SHELF RUNNERS

Side liners with shelf runners:

Lift the front part of the shelf runner upwards. Press the entire shelf runner and release the front hook from its housing. Then, gently pull the whole of the shelf runner towards you to release the rear hooks from their housing. Pull out the two shelf supports.

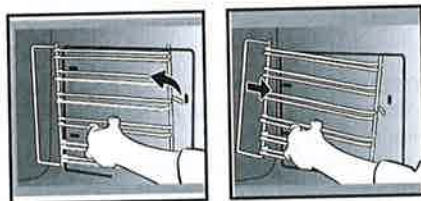

CLEANING THE INNER GLASS

To clean the inner glass, remove the door. Before doing this, remove any excess grease with a soft cloth and washing up liquid.

Warning
Do not use scouring products, abrasive sponges or metal scrapers to clean the glass oven door as this could scratch the surface and cause the glass to shatter.

REMOVING AND PUTTING BACK THE DOOR

Open the door fully and block it with one of the plastic wedges provided in your appliance's plastic pouch.

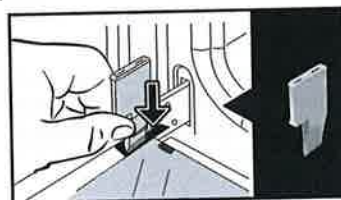

Remove the first clipped glass panel: Using the other wedge (or a screwdriver), press the slots **A** to unclip the glass.

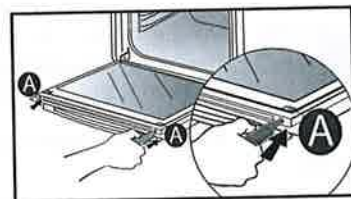

Remove the glass panel.

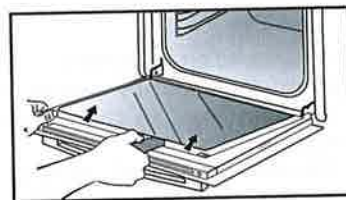

The door consists of two additional glass panels, with a black rubber spacer at each corner.

• 5 CARE

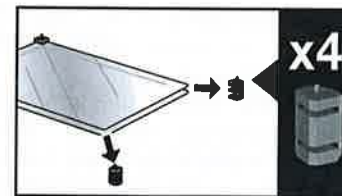

If necessary, remove them to clean them. **Do not soak the glass panels in water.** Rinse with clean water and dry off with a lint-free cloth.

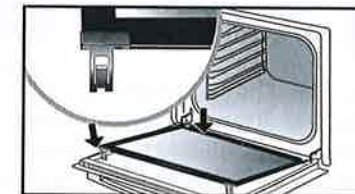

Remove the plastic wedge. Your appliance is now ready for use again.

After cleaning, reposition the four rubber stops with the arrow upwards and reposition all of the glass panels.

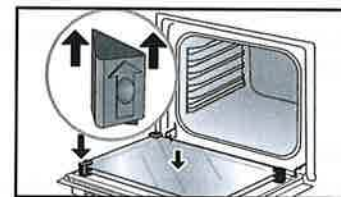

Insert the last glass panel into the metal stops, then clip it in with the side with «PYROLYTIC» facing you and legible.

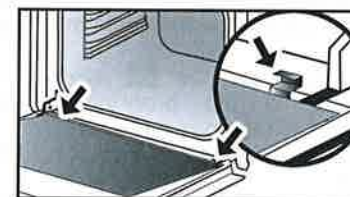

• 5 CARE



“CLEANING” FUNCTION (the cavity)

⚠ Remove the accessories and supports from the oven before beginning pyrolysis cleaning. Before starting a pyrolysis cleaning cycle, make sure that any accessories that are not pyrolysis safe have been removed from the oven (sliding rails, baking trays, chrome-plated grills, and so on) as well as any cookware.

PYROLYTIC SELF-CLEANING

This oven is equipped with a pyrolytic self-cleaning function:

Pyrolysis is a cycle during which the oven cavity is heated to a very high temperature in order to eliminate soiling from splattering and spills.

Before starting pyrolysis cleaning, remove any large overspills, if any. Remove the excess grease on the door using a damp sponge.

As a safety measure, cleaning only occurs after the door locks automatically; it is impossible to unlock the door.

PERFORM A SELF-CLEANING CYCLE

Three pyrolysis cycles are proposed. The durations are pre-selected and cannot be modified:

Express Pyro: in 59 minutes

This specific function uses the heat built up during a previous cooking cycle to quickly and automatically



clean the inside of the oven: it cleans a mildly dirty oven interior in less than an hour.

The electronic oven temperature monitor determines whether the residual heat remaining in the oven interior is sufficient to provide a good cleaning result. If this is not the case, a **90-minute pyrolysis cycle will automatically begin.**



Auto Pyro: between 1:30 and 2:15 for cleaning to save energy.



Turbo Pyro: in 2:00 for more in-depth cleaning of the inside of the oven.

IMMEDIATE SELF CLEANING

- Select the «CLEANING» function when you are in the general menu then confirm.
- Select the most suitable self cleaning cycle, for example Turbo Pyro, and confirm.

The pyrolysis cycle begins. The time starts to count down immediately it is set.

During pyrolysis, the  symbol is displayed in the programmer to indicate that the door is locked.

At the end of the pyrolysis cycle, 0:00 flashes.

There is a 30 minute cooling phase after each pyrolysis and your oven remains unavailable during this time.



When the oven is cool, use a damp cloth to remove the white ashes. The oven is clean again and

• 5 CARE

ready for further cooking operations.

SELF CLEANING WITH DELAYED START

Follow the instructions described in the previous section.

- Select the end time symbol (delayed start)  and confirm.

- Set the pyrolysis end time you want with the control knob and confirm.

After these steps, the oven switches to standby and the start of pyrolysis is delayed so that it finishes at the programmed time.

When your pyrolysis is complete, switch your oven off by pressing the  key.



REPLACING THE LIGHT BULB



Warning
Make sure the appliance is disconnected from the power before replacing the bulb in order to avoid the risk of electric shock. Carry out the operation when the appliance has cooled.

Bulb specification:

25 W, 220-240 V~, 300°C, G9.

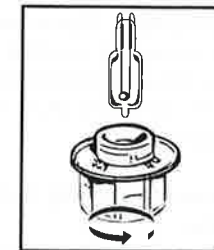

You can replace the bulb yourself. Unscrew the view port and remove the bulb (use a rubber glove, which will make it easier to remove). Insert the new bulb and replace the view port.

• 6 ANOMALIES AND SOLUTIONS

- **«AS» is displayed (Auto Stop system).** This function stops heating the oven if you forget to switch it off. Turn your oven to STOP.

- **Default code starting with «F».** Your oven has detected a problem. Stop the oven for 30 minutes. If the fault is still there, cut off the power supply for at least one minute. If the fault persists, contact the Customer Service Department.

- **The oven is not heating.** Check that the oven is correctly connected and that your installation's fuse is not out of service. Check that the oven is not set to «DEMO» mode (see settings menu).

- **The oven light is not working.** Replace the bulb or the fuse. Check that the oven is correctly connected.

- **The cooling fan continues to operate after the oven stops.** This is normal. It can work for up to one hour after cooking to cool down the oven. If it continues beyond this, contact the Customer Service Department.

- **The pyrolysis cleaning cycle does not begin.** Verify that the door is locked. Call the Customer Services Department if the problem persists.

- **The «door locking» symbol flashes in the display.** Door locking fault. Contact the Customer Services Department.

• 7 AFTER-SALES SERVICE

SERVICING AND REPAIRS

Any repairs to your appliance must be made by a qualified professional accredited to work on the brand. When calling, please provide the full references of your appliance (commercial reference, service reference, serial number), so that we can handle your call better. This information appears on the manufacturer's nameplate on the equipment.

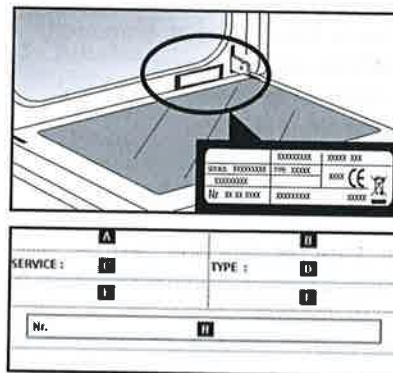

B: Commercial reference
C: Service reference
H: Serial number

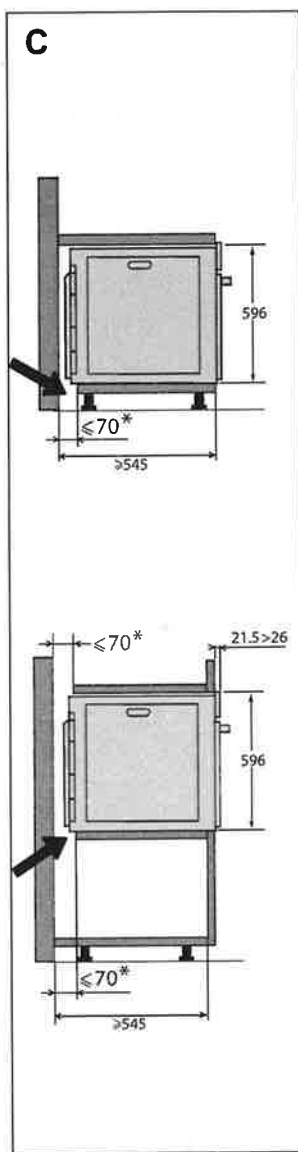
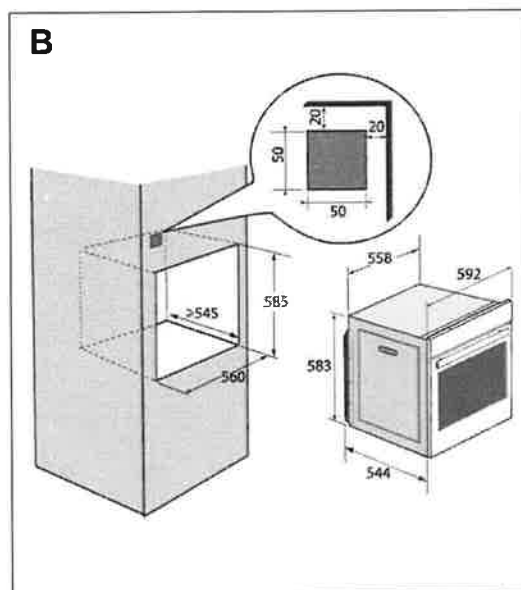
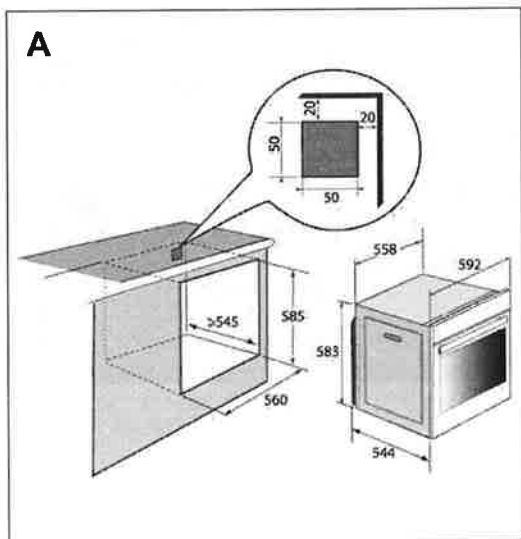

IMPORTANT SAFETY INSTRUCTIONS

IMPORTANT SAFETY INSTRUCTIONS - READ CAREFULLY AND RETAIN FOR FUTURE USE.

This user guide is available for download on the brand's website.

When you receive the appliance, unpack it or have it unpacked immediately. Check its general appearance. Make a note of any reservations on the delivery slip and keep a copy.



Important:

This appliance may be used by children aged 8 years and older, and by persons with impaired physical sensorial or mental capacities, or without experience or knowledge, if they are supervised or have received prior instructions on how to use the appliance safely and have understood the risks involved. Children must not be allowed to play with the appliance. Cleaning and maintenance operations must not be carried out by children without supervision.

— Children must be supervised to prevent them from playing with the appliance.

WARNING:

— The appliance and its accessible parts become hot during use. Be careful not to touch the heating elements inside the oven. Children under

8 years old must not be allowed near it unless they are supervised at all times.

— This appliance is designed to cook with the door closed.

— Before pyrolytic cleaning of your oven, remove all accessories and any thick deposits.

— During cleaning, the surfaces may become warmer than under normal conditions of use. It is advisable to keep children away from the appliance.

— Do not use a steam cleaner.

— Do not use abrasive cleaning products or hard metal scrapers for cleaning the oven's glass door, as they could scratch the surface and cause the glass to shatter.



WARNING :

Make sure the appliance is disconnected from the power before replacing the lamp in order to avoid the risk of electric shock. Change the lamp only when the appliance has cooled down. To unscrew the view port and the light, use a rubber glove, which will make disassembly easier.

IMPORTANT SAFETY INSTRUCTIONS

 The electrical plug must remain accessible after installation.

— It must be possible to disconnect the appliance from the power supply, either using a plug or by fitting a switch on the fixed wiring system in accordance with installation rules.

— If the power cable is damaged, it should be replaced by the manufacturer, its after-sales service department or by a similarly qualified person in order to avoid danger.

— This appliance may be installed either under a worktop or in a cabinet column, as indicated on the installation diagram.

— Centre the oven in the unit so as to ensure a minimum distance of 10 mm between the appliance and the surrounding unit. The material of the unit supporting the appliance must be heat-resistant (or covered with a heat-resistant material). For greater stability, attach the oven to the unit with 2 screws through the holes provided on the side panels.

— In order to avoid overheating, the appliance must not be installed behind a decorative door.

— This appliance is designed to be used for domestic and similar applications such as:

Kitchen areas for the staff of shops, offices and other professional premises.

Farms. Use by clients of hotels, motels and other residential type establishments; guest house type environments.

— The oven must be turned off when cleaning inside the oven.

Do not modify the characteristics of this appliance; doing so could be dangerous.

Do not use your oven as a larder or to store any items after use.

• 1 INSTALLATION



CHOICE OF LOCATION AND FITTING

The diagrams show the dimensions of a cabinet that will be able to hold your oven.

This appliance may be installed either under a worktop (**fig. A**) or in a column (**fig. B**).

Caution: if the back of the furniture is open (under a worktop or in a column), the space between the wall and the surface on which the oven rests must be no more than 70 mm* (**fig. C**).

If the furniture is closed at the back, make a 50 x 50 mm opening through which to route the electrical cable.

Install the oven in the furniture. To do this, remove the rubber stops and pre-drill a 2-mm diameter hole in the wall of the furniture to avoid splitting the wood. Attach the oven with the two screws. Re-position the rubber stops.

Advice

To be certain that you have properly installed your appliance, do not hesitate to call on a household appliance specialist.

WIRING IN

The oven must be connected via a standardised power cable with 3 conductors of 1.5mm² (1 live + 1 neutral + earth) which must be connected to a 220-240V single-phase system by means of an IEC 60083 standard power socket or via an all-pole cut-off device in compliance with the installation rules.

The safety wire (green-yellow) is connected to the appliance's terminal and must be connected to the installation's earth. The fuse in your set-up must be 16 amperes.

We cannot be held responsible for any accident or incident resulting from non-existent, defective or incorrect earthing or non-compliant connection.

 **Warning:**
If the electrical installation in your residence requires any changes in order to hook up your appliance, call upon a professional electrician. If the oven malfunctions in any way, unplug the appliance or remove the fuse corresponding to the sector where the oven is hooked up.

• 2 ENVIRONMENT



CARE FOR THE ENVIRONMENT

The packaging of this appliance can be recycled. Help to recycle them and protect the environment by placing them in the municipal containers provided for this purpose.

Your appliance also contains many recyclable materials. It therefore is marked with this symbol to indicate that appliances to be disposed of  should not be mixed with other waste.



This way, the appliance recycling organised by your manufacturer will be done with maximum efficiency, in compliance with European Directive 2002/96/EC on Waste Electrical and Electronic Equipment.

Contact your local authority or retailer for information on used appliance collection points close to your home.

Thank you for co-operation in protecting the environment.